

33 500 882



- sporgenza 137 mm
- bocca girevole 360°
- Getto circolare con aria
- altezza rubinetteria 295 mm
- altezza fino al rompigitto 187 mm
- diametro foro 35 mm
- 2x tubo flessibile di mandata M 8 x 1 avvitato, tenuta controllata
- portata max 5,7 l/min
- senza piombo
- Questo prodotto può aiutare un edificio a soddisfare i requisiti dei Green Building Rating Systems, ad es. LEED®, BREEAM®, DGNB

Solamente per lavabo con troppopieno.

	Cromato	33 500 882-00
	Platinato spazzolato	33 500 882-06
	Platinato	33 500 882-08
	Dark Chrome	33 500 882-19
	Ottone spazzolato (Oro 23k)	33 500 882-28
	Nero opaco	33 500 882-33
	Champagne spazzolato (Oro 22k)	33 500 882-46
	Champagne (Oro 22k)	33 500 882-47
	Cromo spazzolato	33 500 882-93
	Dark Platinum spazzolato	33 500 882-99

33 500 882



Diagramma di portata



Certificati

LGA_38418.

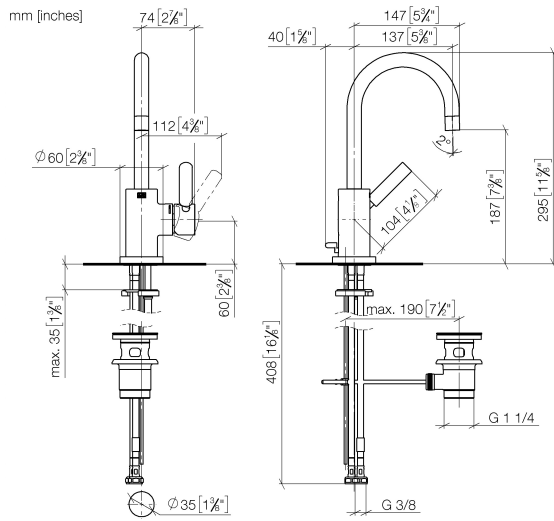
WRAS_2212025.

33 500 882

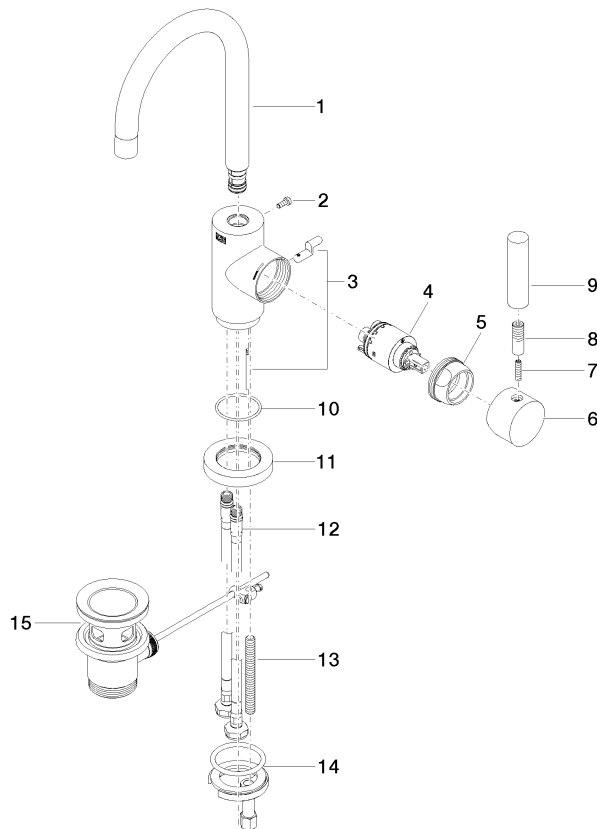

Elenco delle parti di ricambio

N.	Codice articolo	Denominazione	Quantità necessaria	Tempo di produzione
1	90 28 22 371 00-00	bocca di erogazione	1	10
2	09 30 30 054 90	vite	1	2
3	04 20 16 031 80-00	astina	1	10
4	90 15 05 065 00 90	cartuccia	1	2
5	09 24 04 107-00	dado	1	10
6	90 20 88 040 00-00	manopola	1	10
7	09 31 11 010 90	perno	1	2
8	90 24 04 048 00-00	ugello	1	10
9	11 170 880-00	manopola	1	10
10	09 14 10 034 90	guarnizione	1	2
11	09 28 10 055-00	rosetta	1	10
12	04 30 04 104 00 90	flessibile	2	2
13	09 31 11 011 90	perno	1	2
14	04 30 11 038 00 90	set di fissaggio	1	2
15	90 11 01 001 00-00	scarico	1	10